



DOMINA PRO 700 - ELEMENTS NEUTRES

**N77TC**



## TOP

### SPÉCIFICATIONS TECHNIQUES:

Dimensions exterieure - LxPxH (cm) 70x73x25

Tiroir

### SPÉCIFICATIONS SUPPLÉMENTAIRES:

Poids (kg) 28

Volume (m3) 0,3

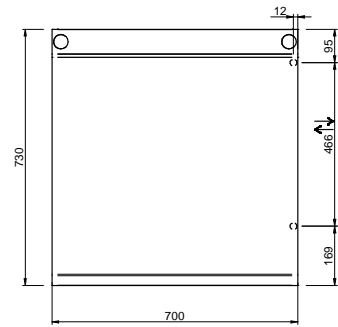
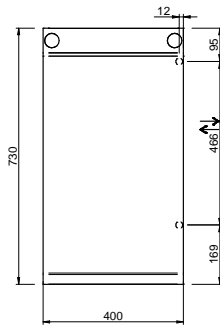
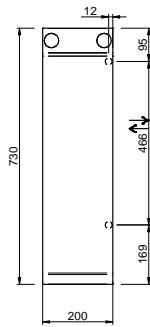
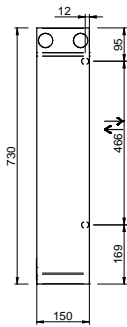
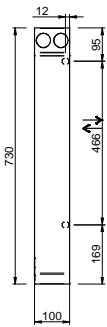
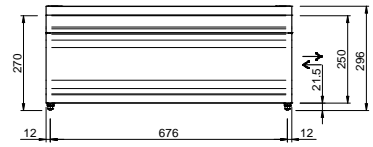
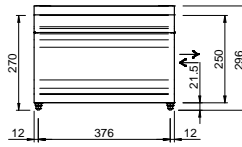
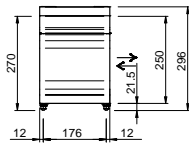
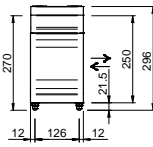
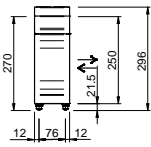

LEGENDA SIMBOLI / LEGEND



INGRESSO GAS / GAS INLET  
(EN 10226-1) Ø M 1/2"



INGRESSO ACQUA /  
WATER INLET Ø M 1/2"



ATTACCO EQUIPOTENZIALE /  
EQUIPOTENTIAL



ALIMENTAZIONE ELETTRICA /  
POWER SUPPLY



SCARICO ACQUA / OLII  
WATER / OILS DRAIN



REGOLAZIONE PIEDINI /  
FEET ADJUSTMENT (h 0/+50)  
/ TOP VERSION (h 0/+5)